

## Circles - circumference

---

### Grade 4 Geometry Worksheet

Find the circumference of each circle from the given radius or diameter.

1.

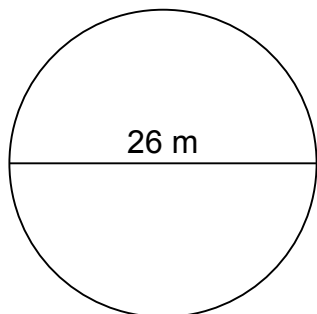

2.

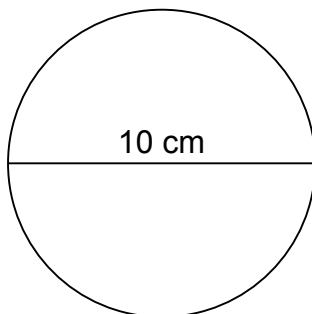

3.

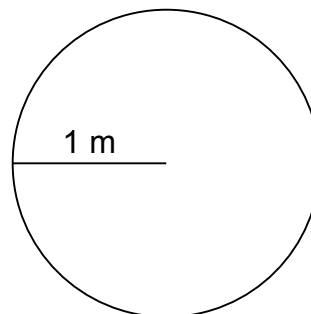

4.

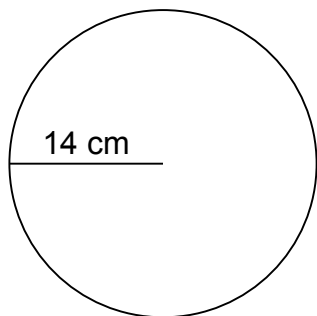

5.

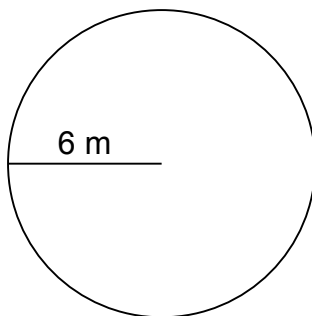

6.

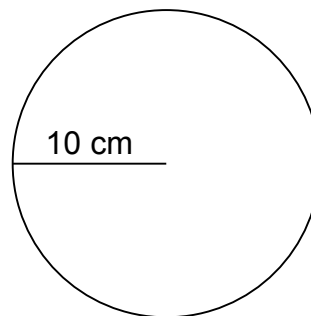

7.

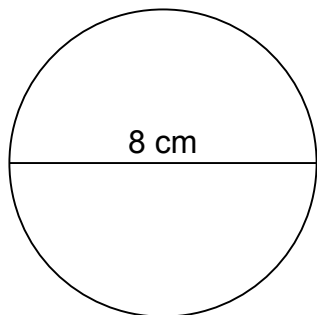

8.

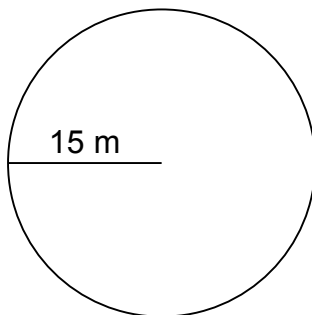

9.

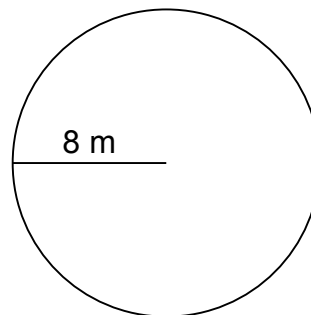

## Circles - circumference

---

### Grade 4 Geometry Worksheet

Find the circumference of each circle from the given radius or diameter.

1.

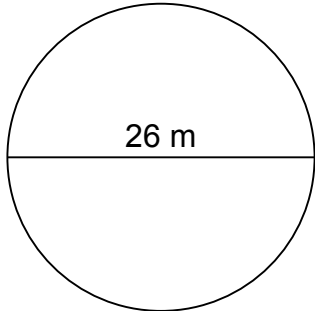

$C=81.64$  m

---

2.

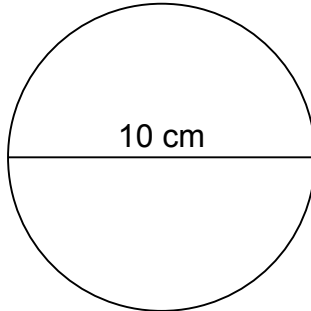

$C=31.40$  cm

---

3.

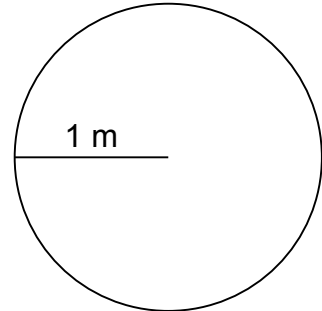

$C=6.28$  m

---

4.

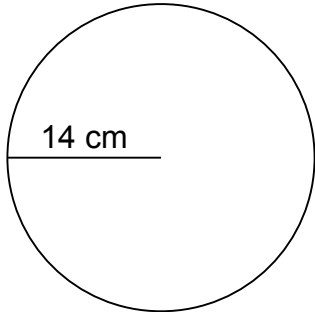

$C=87.92$  cm

---

5.

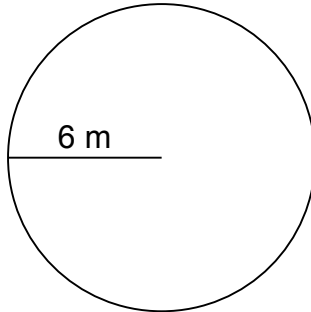

$C=37.68$  m

---

6.

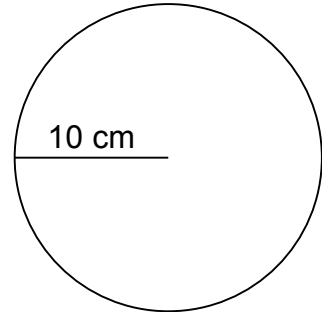

$C=62.80$  cm

---

7.

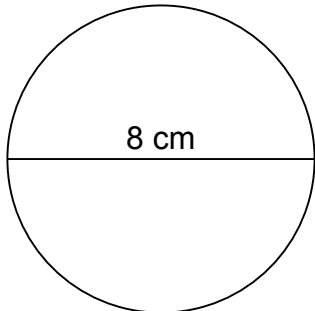

$C=25.12$  cm

---

8.

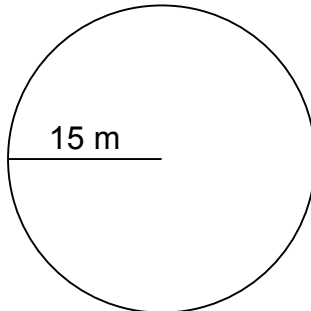

$C=94.20$  m

---

9.

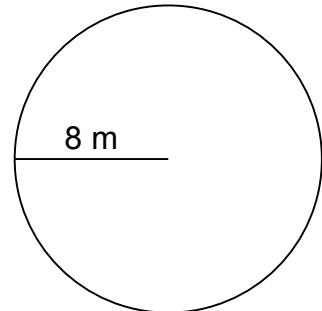

$C=50.24$  m

---