

## Rectangular prism - volume & surface area

---

### Grade 6 Geometry Worksheet

Find the volume and surface area.

1.

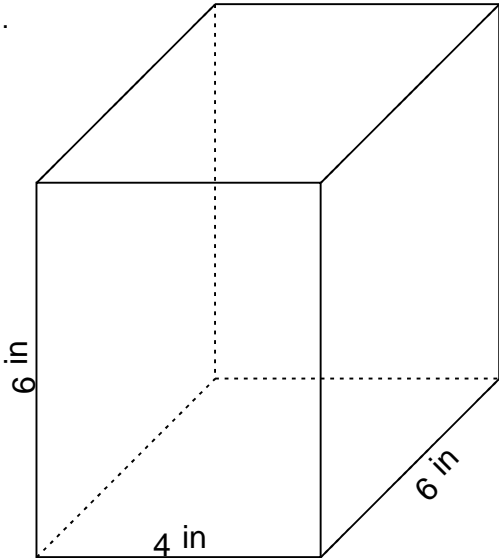

2.

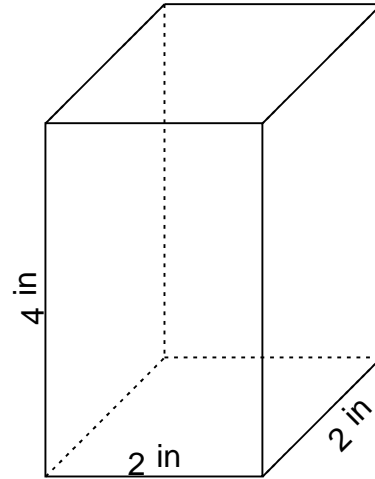

3.

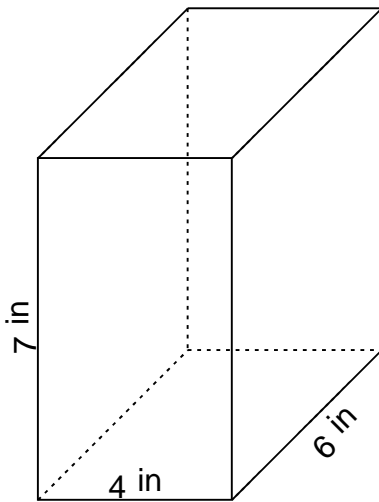

4.

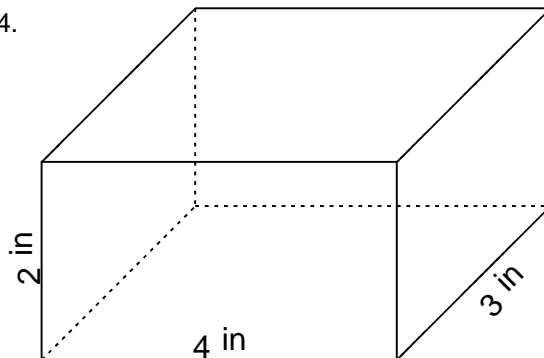

## Rectangular prism - volume & surface area

### Grade 6 Geometry Worksheet

Find the volume and surface area.

1.

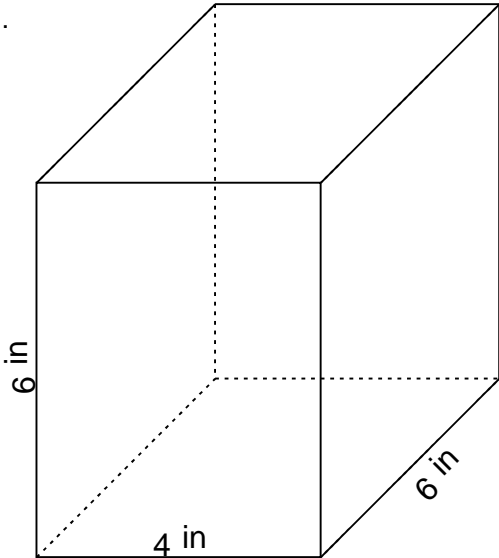

---

$$V = 144 \text{ in}^3 \quad SA = 168 \text{ in}^2$$

2.

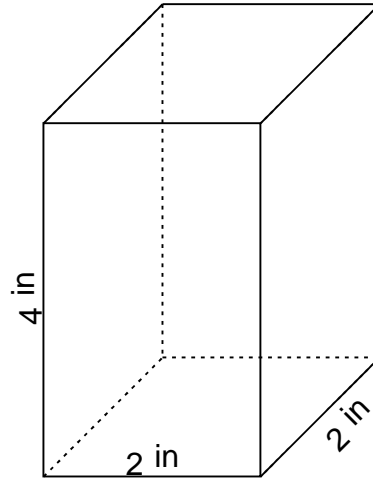

---

$$V = 16 \text{ in}^3 \quad SA = 40 \text{ in}^2$$

3.

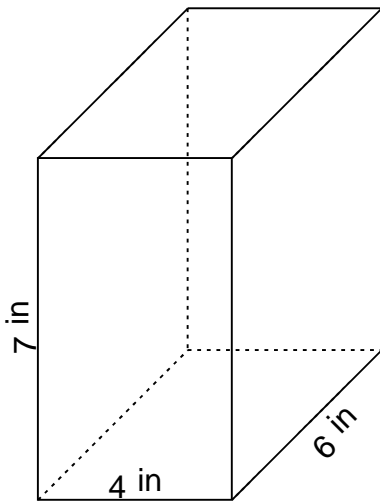

---

$$V = 168 \text{ in}^3 \quad SA = 188 \text{ in}^2$$

4.

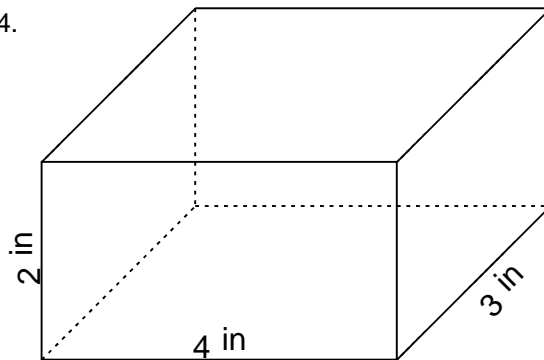

---

$$V = 24 \text{ in}^3 \quad SA = 52 \text{ in}^2$$